

SPECIFICATION

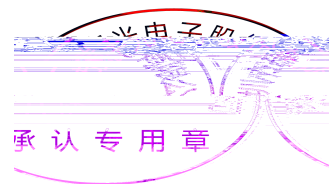

Contents

1. Description	
1.1 General Description	3
1.2 Features	3
1.3 Application	3
1.4 Package Dimension	4
1.5 Product Parameters	5
1.6 Typical optical characteristics curves	6
2. Packaging	
2.1 Packaging Specification	9
2.1.1 Carrier Tape Dimension	9
2.1.2 Reel Dimension	10
2.1.3 Label Form Specification	10
2.2 Moisture Resistant Packing	11
2.3 Cardboard Box	11
2.4 Reliability Test Items And Conditions	12
2.5 Criteria For Judging Damage	12
3. SMT Reflow Soldering Instructions SMT	
3.1 SMT Reflow Soldering Instructions SMT	1305 20...
3.1.1 Soldering Iron	14
3.1.2 Repairing	14
3.1.3 Cautions	15
4. Handling Precautions	

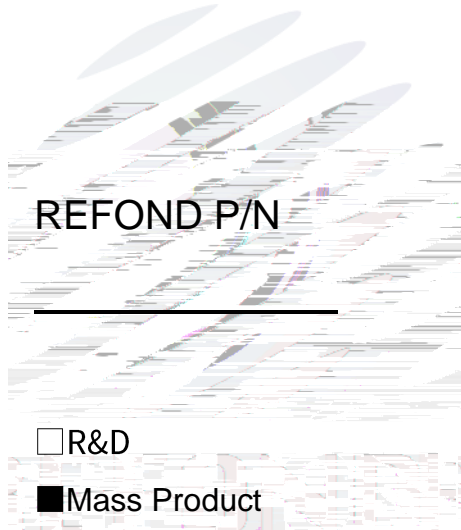
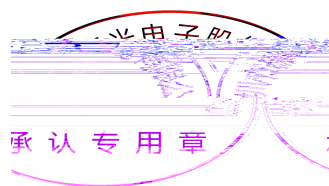

1.4 Package Dimension

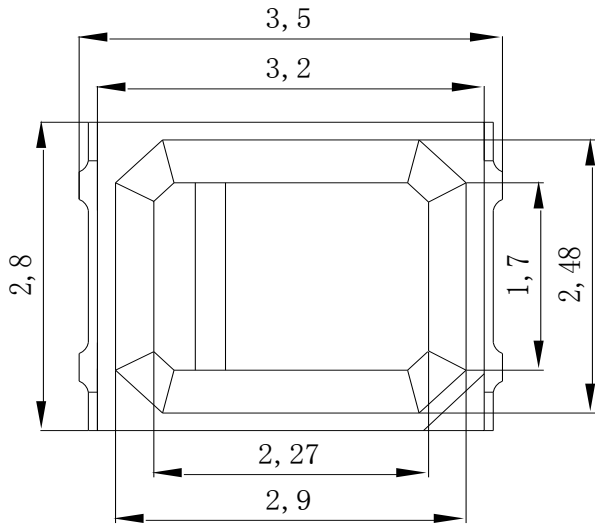

Fig.1-1 Top view

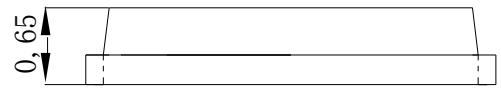

Fig.1-2 Side view

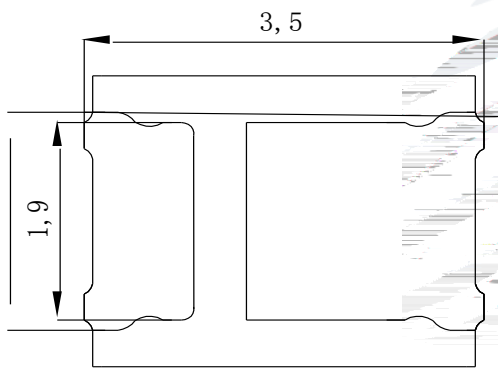

Fig.1-3 Bottom view

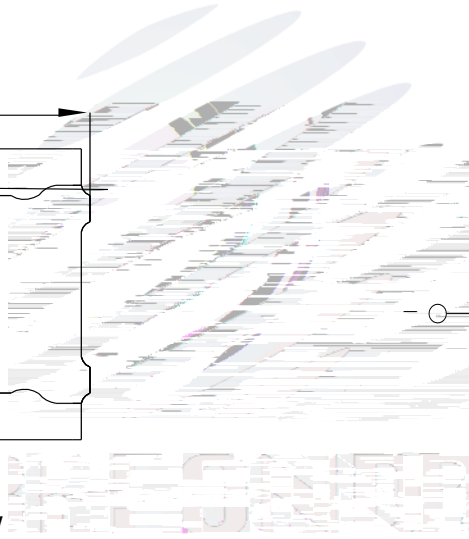

Fig.1-4 Polarity

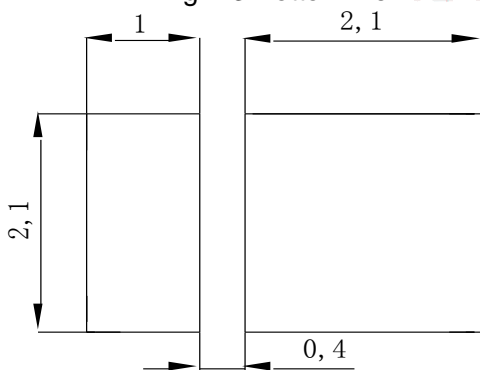
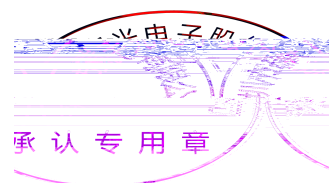

Fig.1-5 Soldering patterns

Notes:

1. All dimensions units are millimeters.
2. All dimensions tolerances are $\pm 0.2\text{mm}$ unless otherwise noted.



1.5 Product Parameters

Table 1-1 Electrical / Optical Characteristics at Ts=25°C

Item	Symbol	Test Condition	Value			Unit
			Min.	Typ	Max.	
Forward Voltage	V_F	$I_F=100mA$	1.8	2.0	2.4	V
Reverse Current	I_R	$V_R=5V$	---	---	10	μA
Total radiant flux	Φ_e	$I_F=100mA$	56	85	---	mW
Peak wavelength	λ_p	$I_F=100mA$	670	680	690	nm
Viewing Angle	2 θ 1/2	$I_F=100mA$	---	120	---	deg
Thermal Resistance.	R_{THJ-S}	$I_F=100mA$	---	15	---	$^{\circ}W$

Table 1-2 Absolute Maximum Ratings at Ts=25°C

Parameter	Symbol	Rating	Units
Power Dissipation	P_D	0.2	W
Forward Current	I_F	100	mA
Peak Forward Current	I_{FP}	150	mA
Reverse Voltage	V_R	5	V
Electrostatic Discharge (HBM)	E_{SD}	2000	V
Operating Temperature	T_{OPR}	-40 ~ +85	
Storage Temperature	T_{OPR}	-40 ~ +100	
Junction Temperature	T_J	115	

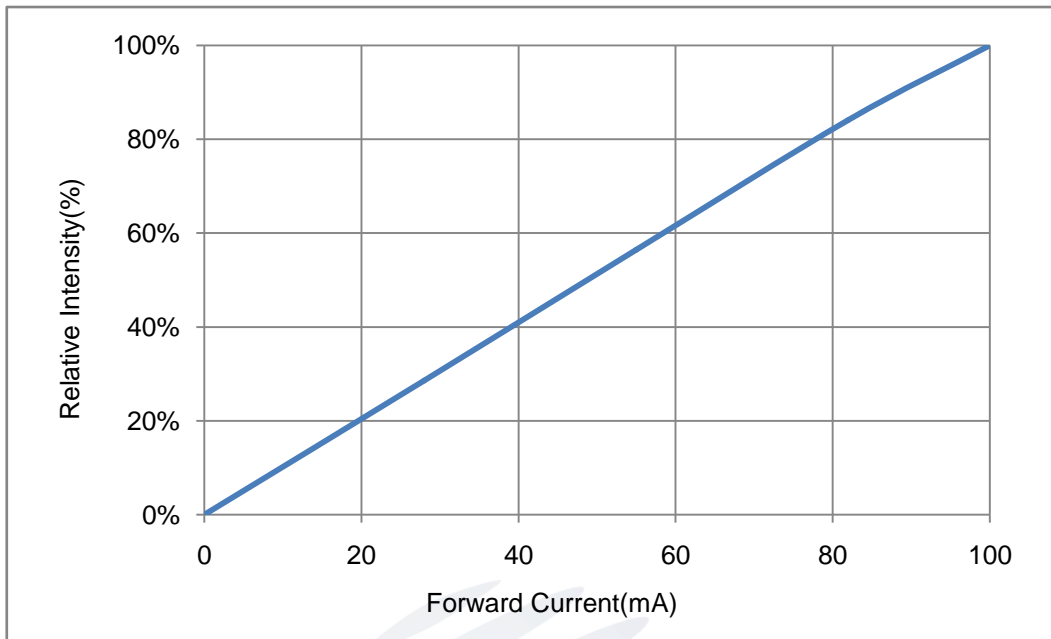

Fig.2- Forward Current Vs. Relative Power

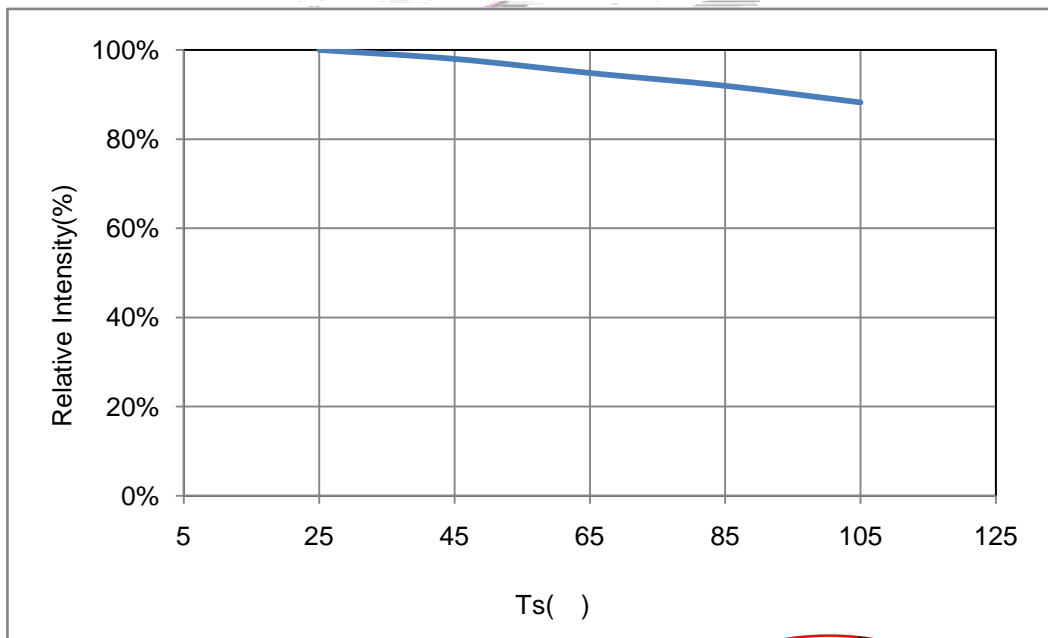
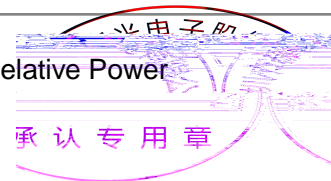

Fig.3-Solder Temperature VS. Relative Power



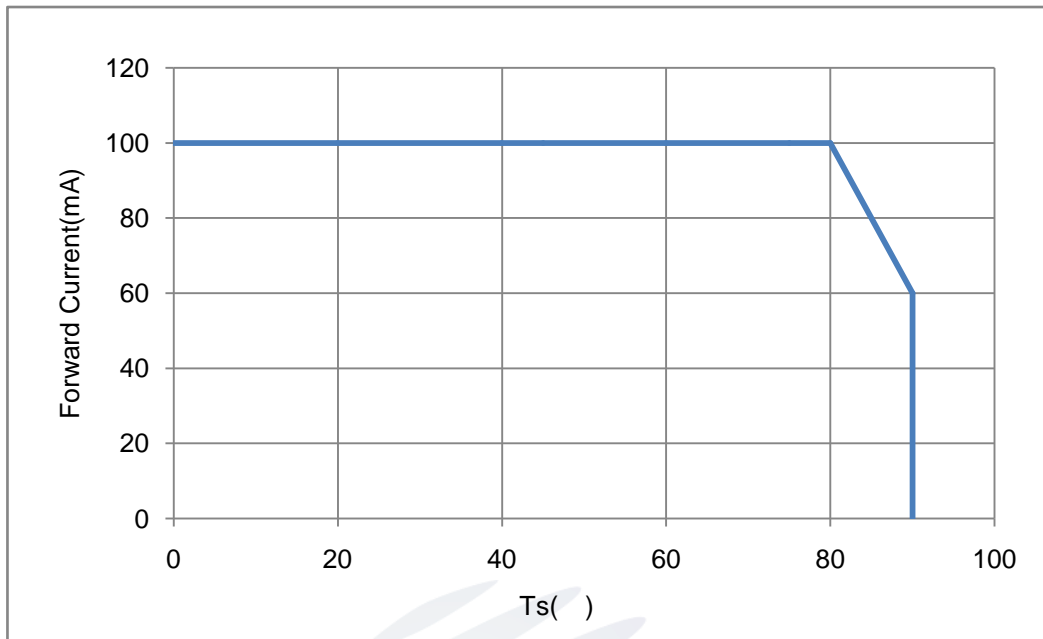

Fig.4-Ts Temperature VS. Forward Current

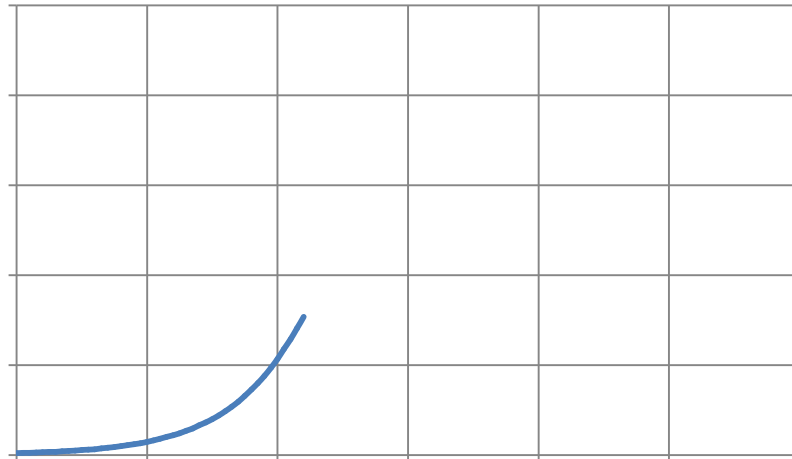

Fig.5-Spectrum Distribution

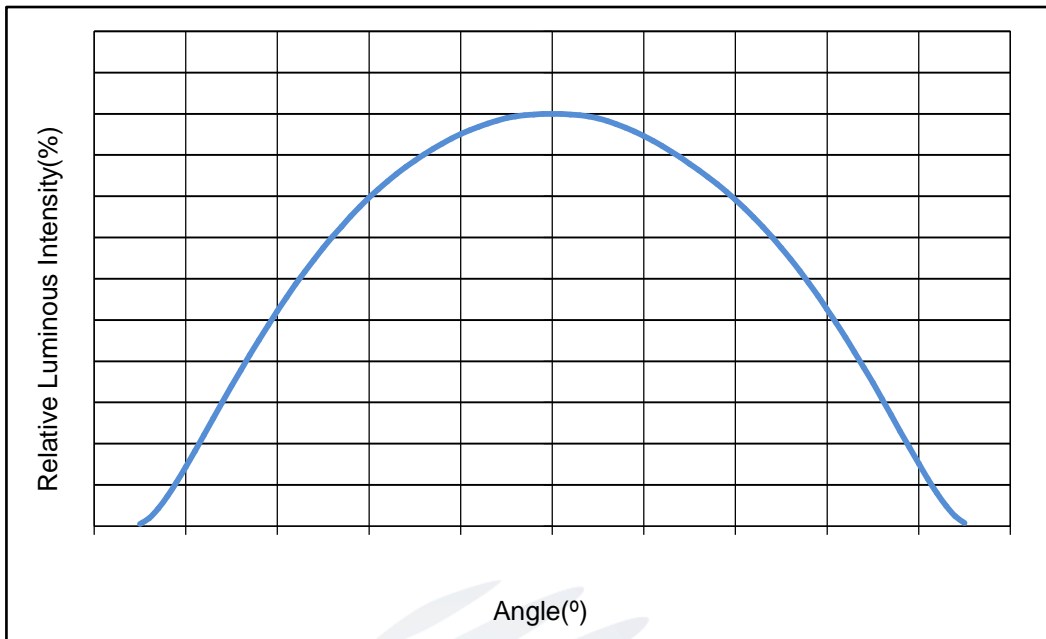

Fig.6- Radiation Diagram

2. Packaging

2.1 Packaging Specification

Package:4000pcs/reel.

2.1.1 Carrier Tape Dimension

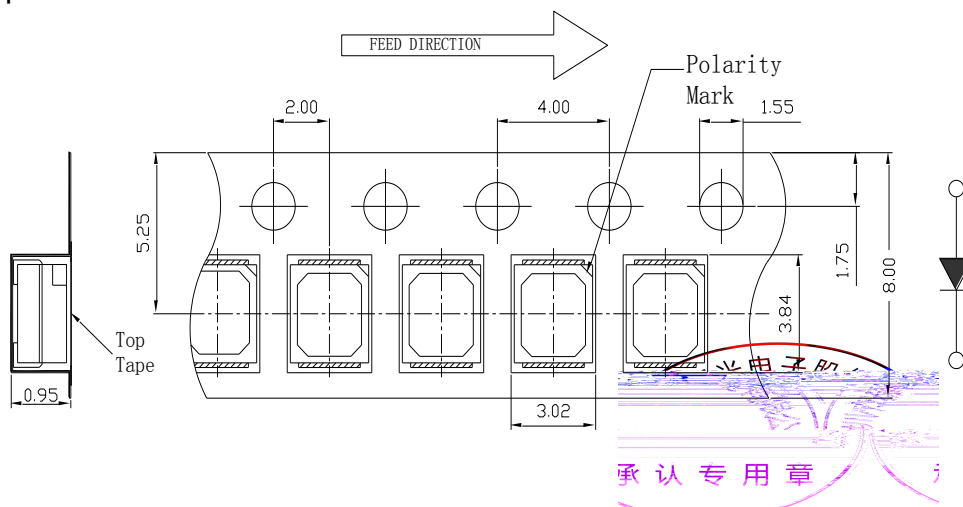
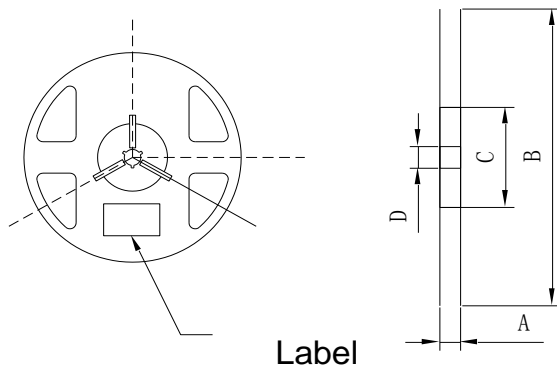

Fig.2-1 Carrier Tape Dimension

2.1.2 Reel Dimension

Table 2-1 Reel Dimension



A	12±0.1mm
B	178±1mm
C	60±1mm
D	13.0±0.5mm

Fig.2-2 Reel Dimension

Notes:

The tolerances unless mentioned ±0.1mm. Unit : mm .

2.1.3 Label Form Specification

Table 2-2 Label Form Specification

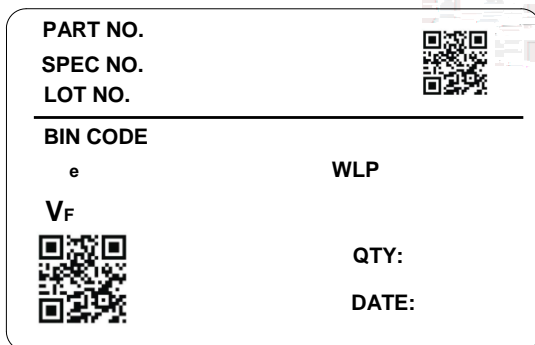

PART NO.	Part Number
SPEC NO.	Spec Number
LOT NO.	Lot Number
BIN CODE	Bin Code
Φ _e	Radiation flux
V _F	Forward Voltage
WLP	Wavelength
QTY	Packing Quantity
DATE	Made Date

Fig. 2-3 Label Form Specification

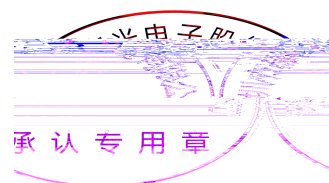

2.2 Moisture Resistant Packing

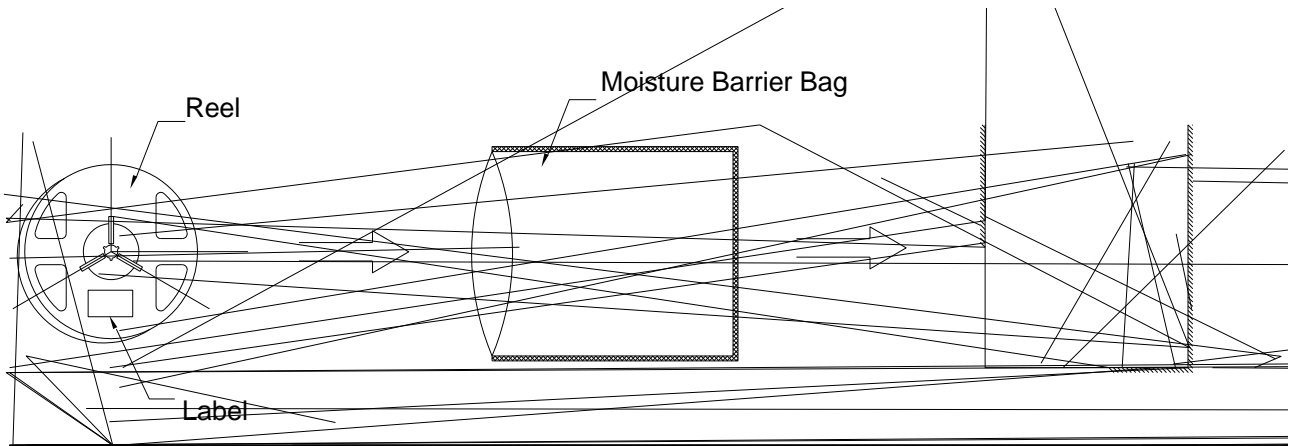

Fig.2-4 Moisture Resistant Packing Process

2.3 Cardboard Box



Fig.2-

2.4 Reliability Test Items And Conditions

Table 2-3 Reliability Test Items And Conditions

Test Items	Ref.Standard	Test Condition	Time	Quantity	Ac/Re
Reflow	JESD22-B106	Temp:260 max T=10 sec	3times.	10Pcs.	0/1
Temperature Cycle	JESD22-A104	100 30 min. ↑↓5 min -40 30 min.	300 Cycles	10Pcs.	0/1
Thermal Shock	JESD22-A106	-40 15min ↑↓10s 100 15min	300 Cycles	10Pcs.	0/1
High Temperature Storage	JESD22-A103	Temp:100	1000Hrs.	10Pcs.	0/1
Low Temperature Storage	JESD22-A119	Temp:-40	1000Hrs.	10Pcs.	0/1
Life Test	JESD22-A108	T _a =25 I _F =100mA	1000Hrs.	10Pcs.	0/1

2.5 Criteria For Judging Damage

Table 2-4 Criteria For Judging Damage

Test Items	Symbol	Test Condition	Criteria For Judgement	
			Min.	Max.
Forward Voltage	V _F	I _F =100mA	-	U.S.L*)x1.1
Reverse Current	I _R	V _R = 5V	-	U.S.L*)x2.0
Total radiant flux	Φ _e	I _F =100mA	L.S.L*)x0.7	-

Notes:

1. U.S.L: Upper standard leve. L.S.L: Lower standard level.
2. The above reliability tests is based on the verification of a single/strip LED of Refond's existing experimental platform, the reliability experiment was taken under good heat dissipation conditions. when customers applies the LED to the series and parallel circuit, should take consideration of all the factors such as the current, voltage distribution, heat dissipation and others.
3. The technical information shown in the data sheets is limited to the typical characteristics and circuit examples of the referenced products. It does not constitute the warranting of industrial property nor the granting of any license.



3. SMT Reflow Soldering Instructions SMT

3.1 SMT Reflow Soldering Instructions SMT

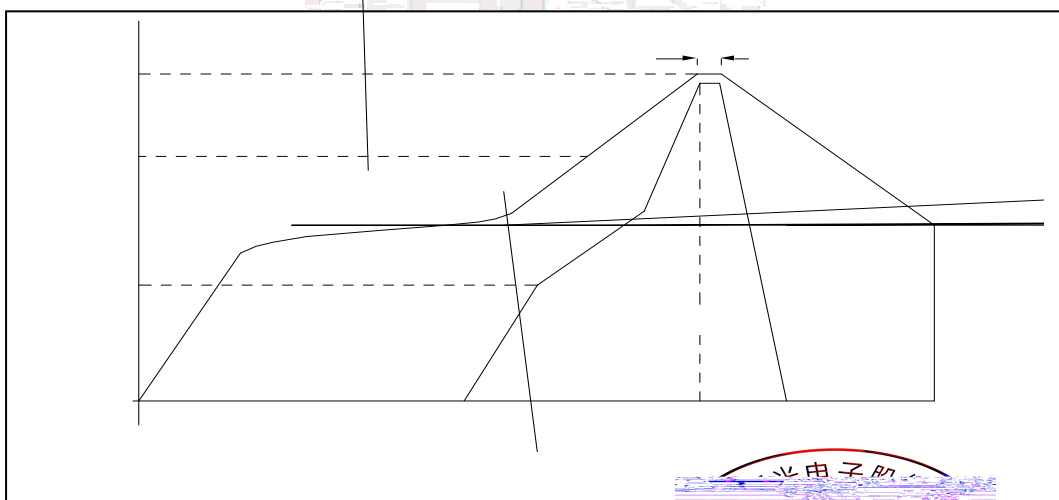

Fig.3-1 SMT Reflow Soldering Instructions SMT

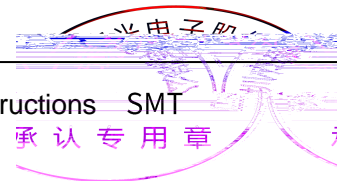
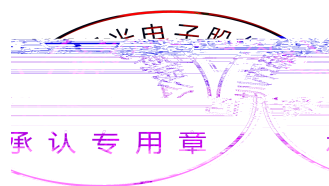

Table 3-1 SMT Reflow Soldering Instructions SMT

Average temperature rise speed (T _{max})	Max 3 °C/ s
Preheating: minimum temperature (T _{min})	150 °C
Preheating: Max temperature (T _{max})	200 °C
Preheating: Time (T _{min} -T _{max})	60s-120s





(4) Handle the component along the side surface by using forceps or appropriate tools; Do not directly touch or Handle the silicone lens surface, it may damage the internal circuitry.

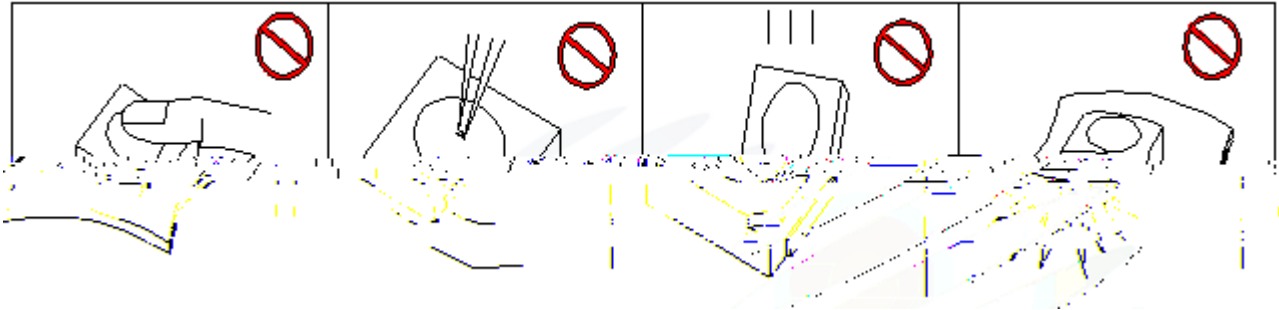

Fig 4-1 Operate Method

(5) In designing a circuit, the current through each LED can not exceed the absolute maximum rating specified for each LED. In the meanwhile, resistors for protection should be applied, otherwise slight voltage shift will cause big current change, burn out may happen. The driving circuit must be designed to allow forward voltage only when it is ON or OFF. If the reverse voltage is applied to LED, migration can be generated resulting in LED damage.

(6) Thermal Design is paramount importance because heat generation may result in the Characteristics decline, such as brightness decreased, Color change and so on. Please consider the heat generation of the LEDs when making the system design.

(7) Compared to standard encapsulants, silicone is generally softer, and the surface is more likely to attract dust, requiring special care during processing. In cases where a minimal level of dirt and dust particles cannot be guaranteed, a suitable cleaning solution must be applied to the surface after the soldering of components. Refond suggests using isopropyl alcohol for cleaning. In case other solvents are used, it must be assured that these solvents do not dissolve the package or resin. Ultrasonic cleaning is not recommended. Ultrasonic cleaning may cause damage to the LED.

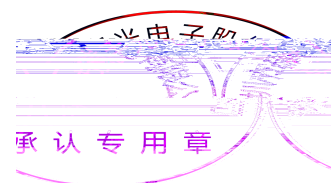

Table 4-1 Storage

Conditions		Temperature	Humidity	Time
Storage	Before Opening Aluminum Bag	≤30°C	≤75%	Within 1 Year From Date
	After Opening Aluminum Bag	≤30°C	≤60%	24hours
Baking		60±5°C	-	≥24hours

(8) If the moisture absorbent material silica gel has faded away or the LEDs have exceeded the storage time, baking treatment should be performed after unpacking and based on the following condition 65 5 for above 24 hours.

If the package is flatulence or damaged, please notify the sales staff to assist.

(9) Similar to most Solid state devices; LEDs are sensitive to Electro-Static Discharge (ESD) and Electrical Over Stress (EOS).

(10) Other points for attention, please refer to our relevant information.

